

1.5A Fast-Response High-Accuracy LDO Linear Regulator with Soft-Start

Check for Samples: [LP38858](#)

FEATURES

- Standard V_{OUT} Values of 0.8V and 1.2V
- Wide V_{BIAS} Supply Operating Range of 3.0V to 5.5V
- Stable with 10 μ F Ceramic Capacitors
- Dropout Voltage of 130 mV (Typical) at 1.5A Load Current
- Precision Output Voltage across All Line and Load Conditions:
 - $\pm 1.0\%$ V_{OUT} for $T_J = 25^\circ\text{C}$
 - $\pm 2.0\%$ V_{OUT} for $0^\circ\text{C} \leq T_J \leq +125^\circ\text{C}$
 - $\pm 3.0\%$ V_{OUT} for $-40^\circ\text{C} \leq T_J \leq +125^\circ\text{C}$
- Over-Temperature and Over-Current Protection
- Available in 5 Lead TO-220 and DDPAK/TO-263 Packages
- Custom V_{OUT} Values between 0.8V and 1.2V are Available
- -40°C to $+125^\circ\text{C}$ Operating Temperature Range

APPLICATIONS

- ASIC Power Supplies In:
 - Desktops, Notebooks, and Graphics Cards, Servers
 - Gaming Set Top Boxes, Printers and Copiers
- Server Core and I/O Supplies
- DSP and FPGA Power Supplies
- SMPS Post-Regulator

Typical Application Circuit

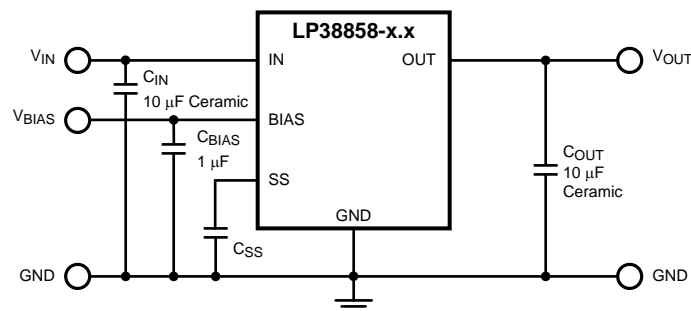

DESCRIPTION

The LP38858 is a high current, fast response regulator which can maintain output voltage regulation with extremely low input to output voltage drop. Fabricated on a CMOS process, the device operates from two input voltages: V_{BIAS} provides voltage to drive the gate of the N-MOS power transistor, while V_{IN} is the input voltage which supplies power to the load. The use of an external bias rail allows the part to operate from ultra low V_{IN} voltages. Unlike bipolar regulators, the CMOS architecture consumes extremely low quiescent current at any output load current. The use of an N-MOS power transistor results in wide bandwidth, yet minimum external capacitance is required to maintain loop stability.

The fast transient response of this device makes it suitable for use in powering DSP, Microcontroller Core voltages and Switch Mode Power Supply post regulators. The LP38858 is available in TO-220 and DDPAK/TO-263 5-Lead packages.

Dropout Voltage: 130mV (typical) at 1.5A load current.

Low Ground Pin Current: 10 mA (typical) at 1.5A load current.

Soft-Start: Programmable Soft-Start time.

Precision Output Voltage: $\pm 1.0\%$ for $T_J = 25^\circ\text{C}$ and $\pm 2.0\%$ for $0^\circ\text{C} \leq T_J \leq +125^\circ\text{C}$, across all line and load conditions



Please be aware that an important notice concerning availability, standard warranty, and use in critical applications of Texas Instruments semiconductor products and disclaimers thereto appears at the end of this data sheet.

All trademarks are the property of their respective owners.

Connection Diagram

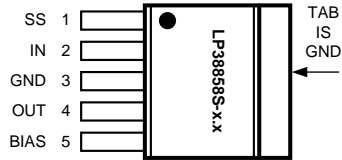

Figure 1. DDPAK/TO-263-5 Package (Top View)
See Package Number KTT0005B

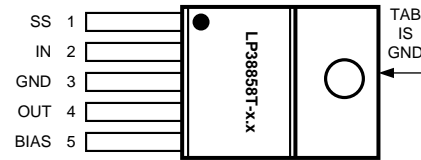

Figure 2. TO220-5 Package (Top View)
See Package Number NDH0005D

Pin Descriptions TO-220-5 and DDPAK/TO-263-5 Packages

Pin #	Pin Symbol	Pin Description
1	SS	Soft-Start capacitor connection. Used to slow the rise time of V_{OUT} at turn-on.
2	IN	The unregulated voltage input pin.
3	GND	Ground
4	OUT	The regulated output voltage pin.
5	BIAS	The supply for the internal control and reference circuitry.
TAB	TAB	The TAB is a thermal connection that is physically attached to the backside of the die, and used as a thermal heat-sink connection. See the Application Information section for details.



These devices have limited built-in ESD protection. The leads should be shorted together or the device placed in conductive foam during storage or handling to prevent electrostatic damage to the MOS gates.

Absolute Maximum Ratings⁽¹⁾⁽²⁾

Storage Temperature Range		-65°C to +150°C
Lead Temperature	Soldering, 5 seconds	260°C
ESD Rating	Human Body Model ⁽³⁾	±2 kV
Power Dissipation ⁽⁴⁾		Internally Limited
V_{IN} Supply Voltage (Survival)		-0.3V to +6.0V
V_{BIAS} Supply Voltage (Survival)		-0.3V to +6.0V
V_{SS} Soft-Start Voltage (Survival)		-0.3V to +6.0V
V_{OUT} Voltage (Survival)		-0.3V to +6.0V
I_{OUT} Current (Survival)		Internally Limited
Junction Temperature		-40°C to +150°C

- (1) Absolute Maximum Ratings indicate limits beyond which damage to the device may occur. Operating Ratings indicate conditions for which the device is intended to be functional, but does not ensure specific performance limits. For ensured specifications and conditions, see the Electrical Characteristics.
- (2) If Military/Aerospace specified devices are required, please contact the Texas Instruments Sales Office/Distributors for availability and specifications.
- (3) The human body model is a 100 pF capacitor discharged through a 1.5k resistor into each pin. Test method is per JESD22-A114. The HBM rating for device pin 1 (SS) is ±1.5 kV.
- (4) Device power dissipation must be de-rated based on device power dissipation (P_D), ambient temperature (T_A), and package junction to ambient thermal resistance (θ_{JA}). Additional heat-sinking may be required to ensure that the device junction temperature (T_J) does not exceed the maximum operating rating. See the [Application Information](#) section for details.

Operating Ratings⁽¹⁾

V_{IN} Supply Voltage	$(V_{OUT} + V_{DO})$ to V_{BIAS}
V_{BIAS} Supply Voltage	3.0V to 5.5V
I_{OUT}	0 mA to 1.5A
Junction Temperature Range ⁽²⁾	-40°C to +125°C

- (1) Absolute Maximum Ratings indicate limits beyond which damage to the device may occur. Operating Ratings indicate conditions for which the device is intended to be functional, but does not ensure specific performance limits. For ensured specifications and conditions, see the Electrical Characteristics.
- (2) Device power dissipation must be de-rated based on device power dissipation (P_D), ambient temperature (T_A), and package junction to ambient thermal resistance (θ_{JA}). Additional heat-sinking may be required to ensure that the device junction temperature (T_J) does not exceed the maximum operating rating. See the [Application Information](#) section for details.

Electrical Characteristics

Unless otherwise specified: $V_{IN} = V_{OUT(NOM)} + 1V$, $V_{BIAS} = 3.0V$, $I_{OUT} = 10$ mA, $C_{IN} = C_{OUT} = 10$ μ F, $C_{BIAS} = 1$ μ F, $C_{SS} =$ open. Limits in standard type are for $T_J = 25^\circ\text{C}$ only; limits in **boldface type** apply over the junction temperature (T_J) range of -40°C to +125°C. Minimum and Maximum limits are ensured through test, design, or statistical correlation. Typical values represent the most likely parametric norm at $T_J = 25^\circ\text{C}$, and are provided for reference purposes only.

Symbol	Parameter	Conditions	MIN	TYP	MAX	Units
V_{OUT}	V_{OUT} Accuracy	$V_{OUT(NOM)} + 1V \leq V_{IN} \leq V_{BIAS}$, $3.0V \leq V_{BIAS} \leq 5.5V$, 10 mA $\leq I_{OUT} \leq 1.5A$	-1.0 -3.0	0	1.0 3.0	%
		$V_{OUT(NOM)} + 1V \leq V_{IN} \leq V_{BIAS}$, $3.0V \leq V_{BIAS} \leq 5.5V$, 10 mA $\leq I_{OUT} \leq 1.5A$, $0^\circ\text{C} \leq T_J \leq +125^\circ\text{C}$	-2.0	0	2.0	
$\Delta V_{OUT}/\Delta V_{IN}$	Line Regulation, V_{IN} ⁽¹⁾	$V_{OUT(NOM)} + 1V \leq V_{IN} \leq V_{BIAS}$	-	0.04	-	%/V
$\Delta V_{OUT}/\Delta V_{BIAS}$	Line Regulation, V_{BIAS} ⁽¹⁾	$3.0V \leq V_{BIAS} \leq 5.5V$	-	0.10	-	%/V
$\Delta V_{OUT}/\Delta I_{OUT}$	Output Voltage Load Regulation ⁽²⁾	10 mA $\leq I_{OUT} \leq 1.5A$	-	0.2	-	%/A
V_{DO}	Dropout Voltage ⁽³⁾	$I_{OUT} = 1.5A$	-	130	165 180	mV
$I_{GND(IN)}$	Quiescent Current Drawn from V_{IN} Supply	LP38858-0.8 10 mA $\leq I_{OUT} \leq 1.5A$	-	7.0	8.5 9.0	mA
		LP38858-1.2 10 mA $\leq I_{OUT} \leq 1.5A$	-	11	12 15	
$I_{GND(BIAS)}$	Quiescent Current Drawn from V_{BIAS} Supply	10 mA $\leq I_{OUT} \leq 1.5A$	-	3.0	3.8 4.5	mA
UVLO	Under-Voltage Lock-Out Threshold	V_{BIAS} rising until device is functional	2.20 2.00	2.45	2.70 2.90	V
UVLO(HYS)	Under-Voltage Lock-Out Hysteresis	V_{BIAS} falling from UVLO threshold until device is non-functional	60 50	150	300 350	mV
I_{SC}	Output Short-Circuit Current	$V_{IN} = V_{OUT(NOM)} + 1V$, $V_{BIAS} = 3.0V$, $V_{OUT} = 0.0V$	-	4.5	-	A
Soft-Start						
r_{SS}	Soft-Start internal resistance	LP38858-0.8	11.0	13.5	16.0	k Ω
		LP38858-1.2	13.5	16.0	18.5	
t_{SS}	Soft-Start time $t_{SS} = C_{SS} \times r_{SS} \times 5$	LP38858-0.8, $C_{SS} = 10$ nF	-	675	-	μ s
		LP38858-1.2, $C_{SS} = 10$ nF	-	800	-	

- (1) Output voltage line regulation is defined as the change in output voltage from nominal value resulting from a change in input voltage.
- (2) Output voltage load regulation is defined as the change in output voltage from nominal value as the load current increases from no load to full load.
- (3) Dropout voltage is defined as the input to output voltage differential ($V_{IN} - V_{OUT}$) where the input voltage is low enough to cause the output voltage to drop 2% from the nominal value.

Electrical Characteristics (continued)

Unless otherwise specified: $V_{IN} = V_{OUT(NOM)} + 1V$, $V_{BIAS} = 3.0V$, $I_{OUT} = 10\text{ mA}$, $C_{IN} = C_{OUT} = 10\text{ }\mu\text{F}$, $C_{BIAS} = 1\text{ }\mu\text{F}$, $C_{SS} = \text{open}$. Limits in standard type are for $T_J = 25^\circ\text{C}$ only; limits in **boldface type** apply over the junction temperature (T_J) range of -40°C to $+125^\circ\text{C}$. Minimum and Maximum limits are ensured through test, design, or statistical correlation. Typical values represent the most likely parametric norm at $T_J = 25^\circ\text{C}$, and are provided for reference purposes only.

Symbol	Parameter	Conditions	MIN	TYP	MAX	Units
AC Parameters						
PSRR (V_{IN})	Ripple Rejection for V_{IN} Input Voltage	$V_{IN} = V_{OUT(NOM)} + 1V$, $f = 120\text{ Hz}$	-	80	-	dB
		$V_{IN} = V_{OUT(NOM)} + 1V$, $f = 1\text{ kHz}$	-	65	-	
PSRR (V_{BIAS})	Ripple Rejection for V_{BIAS} Voltage	$V_{BIAS} = V_{OUT(NOM)} + 3V$, $f = 120\text{ Hz}$	-	58	-	
		$V_{BIAS} = V_{OUT(NOM)} + 3V$, $f = 1\text{ kHz}$	-	58	-	
e_n	Output Noise Density	$f = 120\text{ Hz}$	-	1	-	$\mu\text{V}/\sqrt{\text{Hz}}$
	Output Noise Voltage $V_{OUT} = 1.8V$	$\text{BW} = 10\text{ Hz} - 100\text{ kHz}$	-	150	-	μV_{RMS}
		$\text{BW} = 300\text{ Hz} - 300\text{ kHz}$	-	90	-	
Thermal Parameters						
T_{SD}	Thermal Shutdown Junction Temperature		-	160	-	$^\circ\text{C}$
$T_{SD(HYS)}$	Thermal Shutdown Hysteresis		-	10	-	
θ_{J-A}	Thermal Resistance, Junction to Ambient ⁽⁴⁾	TO-220-5	-	60	-	$^\circ\text{C}/\text{W}$
		DDPAK/TO-263-5	-	60	-	
θ_{J-C}	Thermal Resistance, Junction to Case ⁽⁴⁾	TO-220-5	-	3	-	
		DDPAK/TO-263-5	-	3	-	

- (4) Device power dissipation must be de-rated based on device power dissipation (P_D), ambient temperature (T_A), and package junction to ambient thermal resistance (θ_{JA}). Additional heat-sinking may be required to ensure that the device junction temperature (T_J) does not exceed the maximum operating rating. See the [Application Information](#) section for details.

Typical Performance Characteristics

Unless otherwise specified: $T_J = 25^\circ\text{C}$, $V_{IN} = V_{OUT(NOM)} + 1\text{V}$, $V_{BIAS} = 3.0\text{V}$, $I_{OUT} = 10\text{ mA}$, $C_{IN} = C_{OUT} = 10\ \mu\text{F}$ Ceramic, $C_{BIAS} = 1\ \mu\text{F}$ Ceramic, $C_{SS} = \text{open}$.

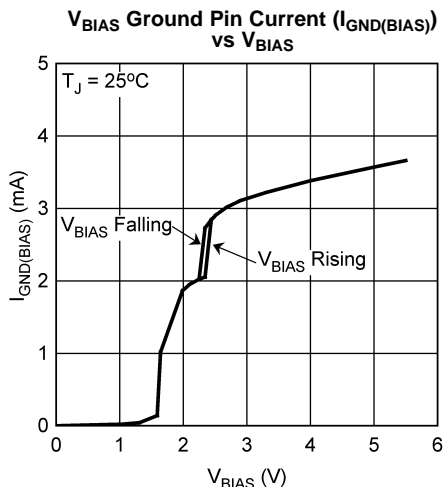

Figure 3.

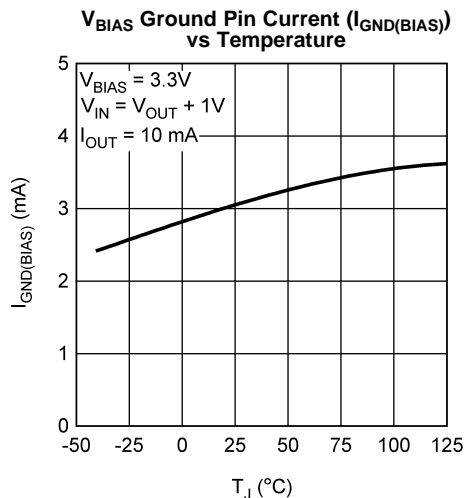

Figure 4.

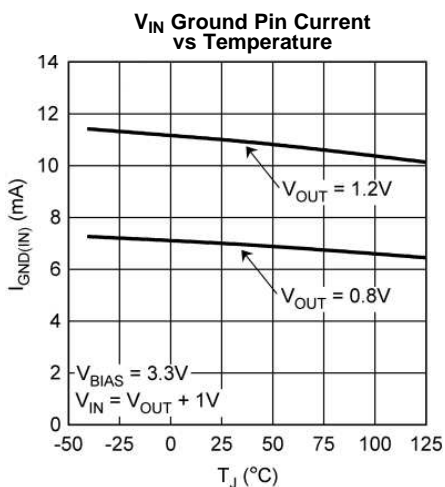

Figure 5.

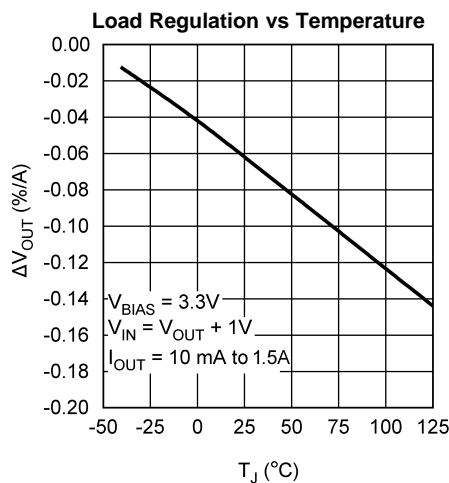

Figure 6.

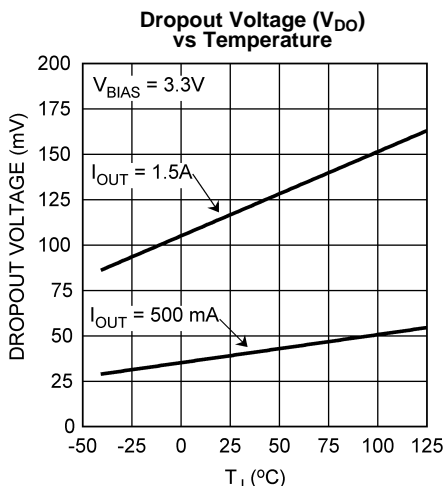

Figure 7.

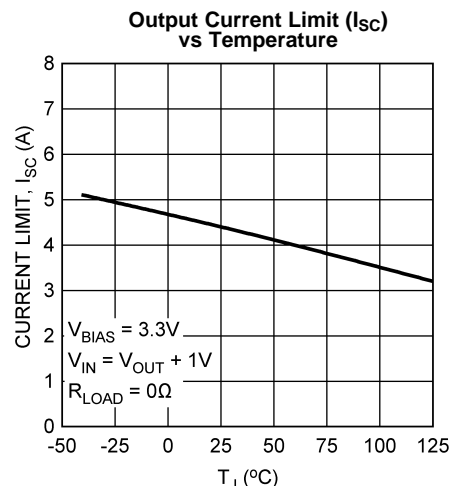

Figure 8.

Typical Performance Characteristics (continued)

Unless otherwise specified: $T_J = 25^\circ\text{C}$, $V_{IN} = V_{OUT(NOM)} + 1\text{V}$, $V_{BIAS} = 3.0\text{V}$, $I_{OUT} = 10\text{ mA}$, $C_{IN} = C_{OUT} = 10\ \mu\text{F}$ Ceramic, $C_{BIAS} = 1\ \mu\text{F}$ Ceramic, $C_{SS} = \text{open}$.

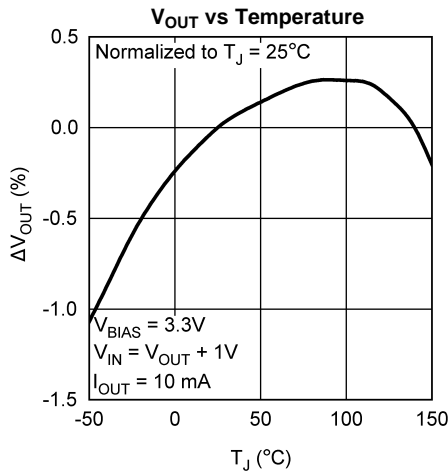

Figure 9.

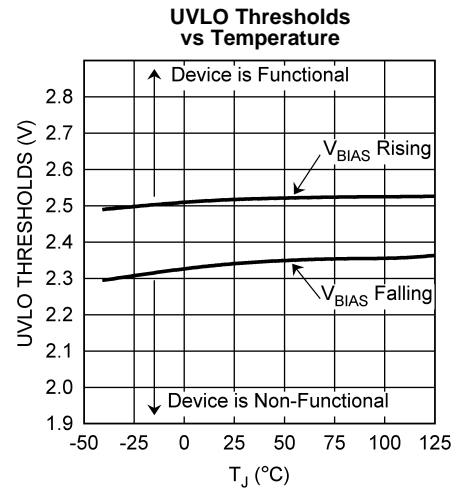

Figure 10.

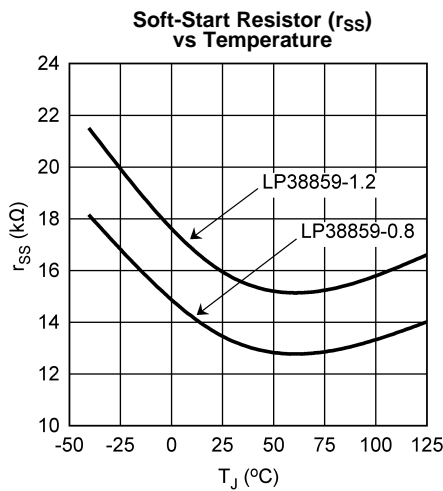

Figure 11.

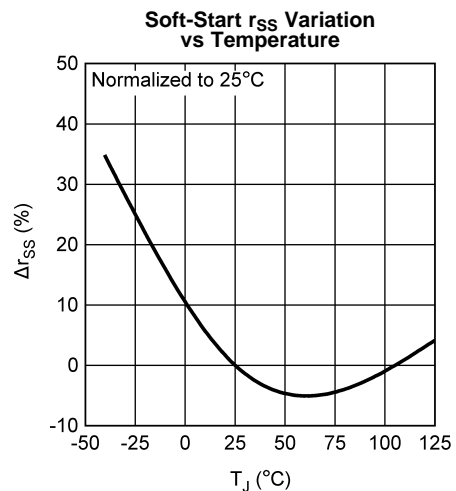

Figure 12.

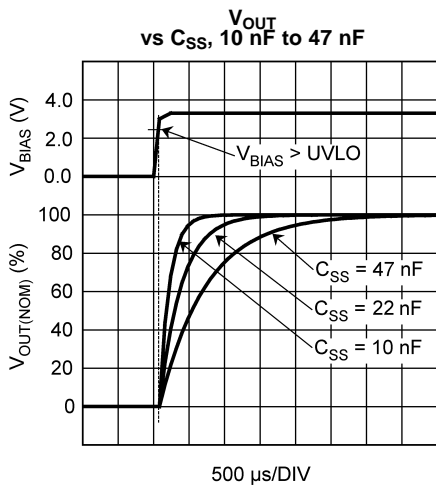

Figure 13.

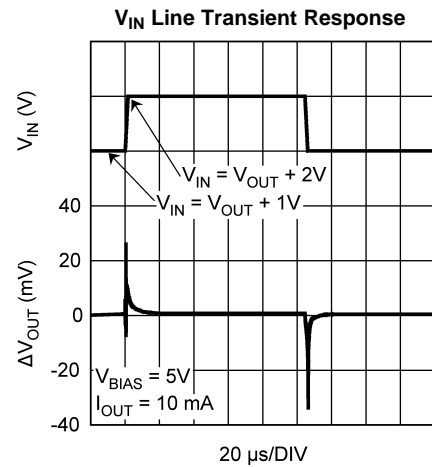

Figure 14.

Typical Performance Characteristics (continued)

Unless otherwise specified: $T_J = 25^\circ\text{C}$, $V_{IN} = V_{OUT(NOM)} + 1\text{V}$, $V_{BIAS} = 3.0\text{V}$, $I_{OUT} = 10\text{ mA}$, $C_{IN} = C_{OUT} = 10\ \mu\text{F}$ Ceramic, $C_{BIAS} = 1\ \mu\text{F}$ Ceramic, $C_{SS} = \text{open}$.

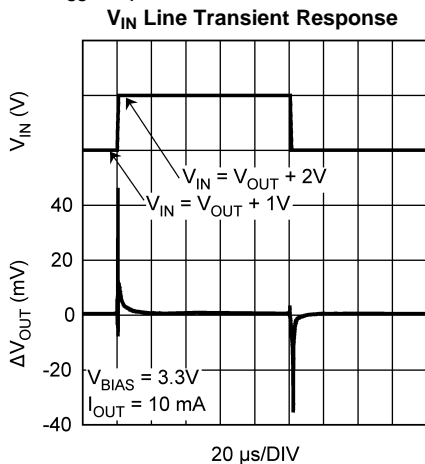

Figure 15.

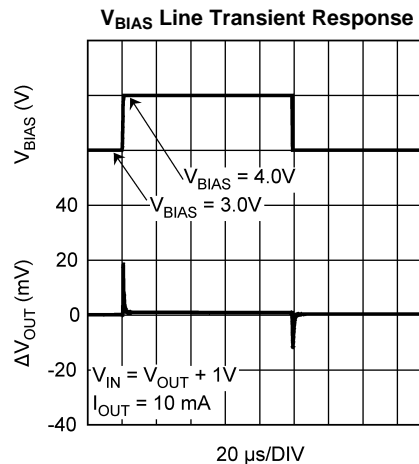

Figure 16.

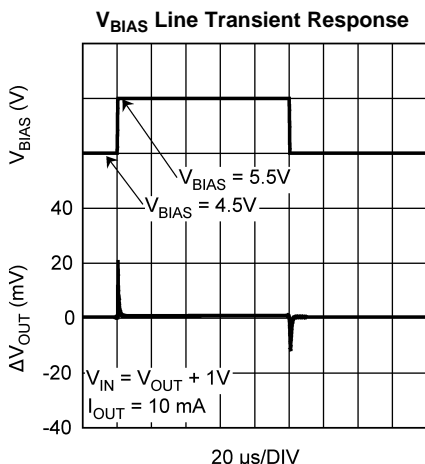

Figure 17.

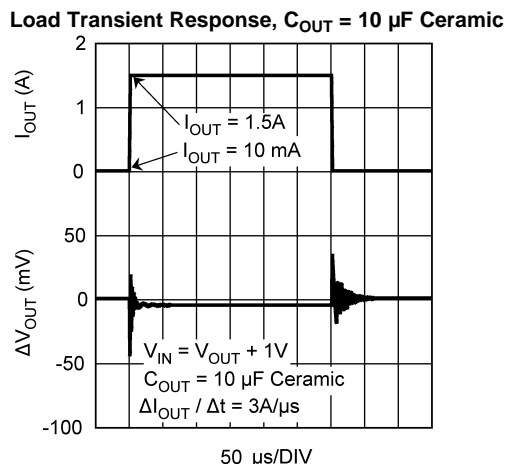

Figure 18.

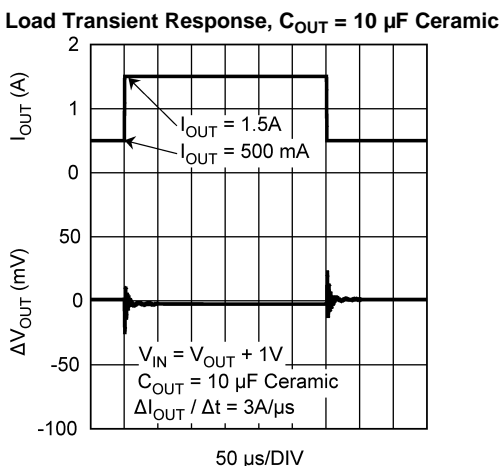

Figure 19.

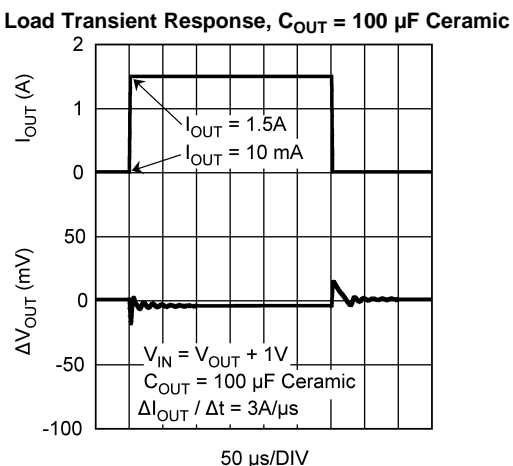

Figure 20.

Typical Performance Characteristics (continued)

Unless otherwise specified: $T_J = 25^\circ\text{C}$, $V_{IN} = V_{OUT(NOM)} + 1\text{V}$, $V_{BIAS} = 3.0\text{V}$, $I_{OUT} = 10\text{ mA}$, $C_{IN} = C_{OUT} = 10\ \mu\text{F Ceramic}$, $C_{BIAS} = 1\ \mu\text{F Ceramic}$, $C_{SS} = \text{open}$.

Load Transient Response, $C_{OUT} = 100\ \mu\text{F Ceramic}$

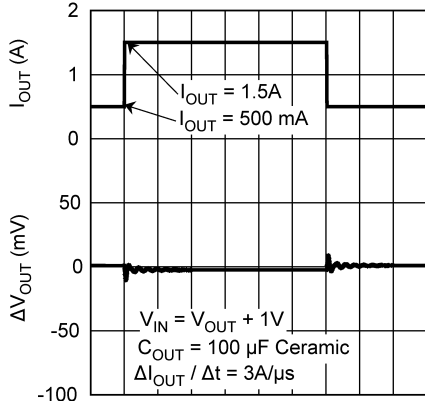

Figure 21.

Load Transient Response, $C_{OUT} = 100\ \mu\text{F Tantalum}$

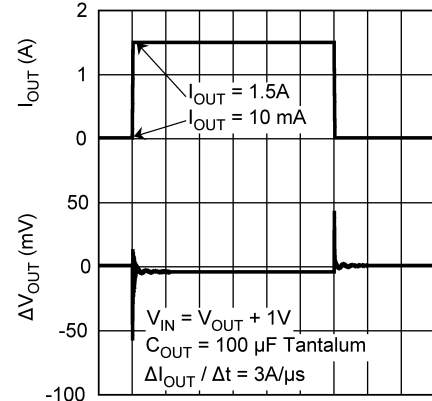

Figure 22.

Load Transient Response, $C_{OUT} = 100\ \mu\text{F Tantalum}$

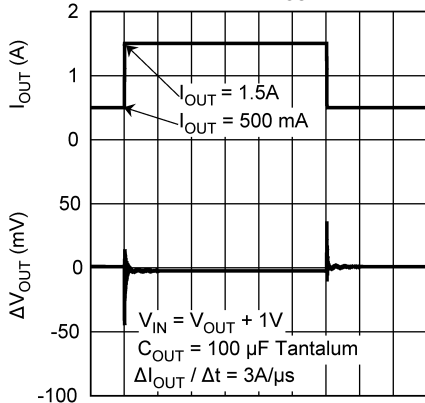

Figure 23.

V_{BIAS} PSRR

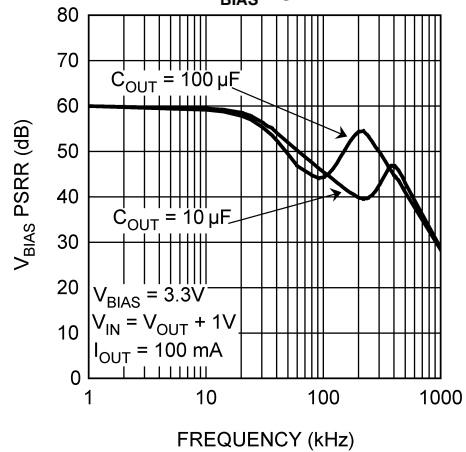

Figure 24.

V_{IN} PSRR

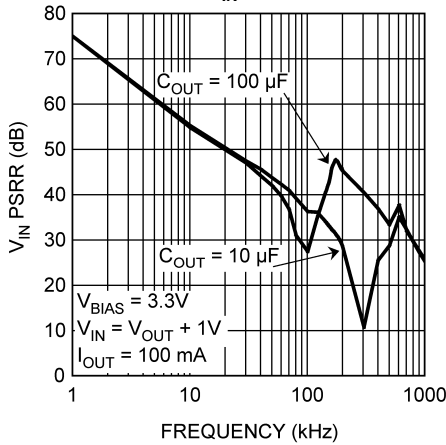

Figure 25.

Output Noise

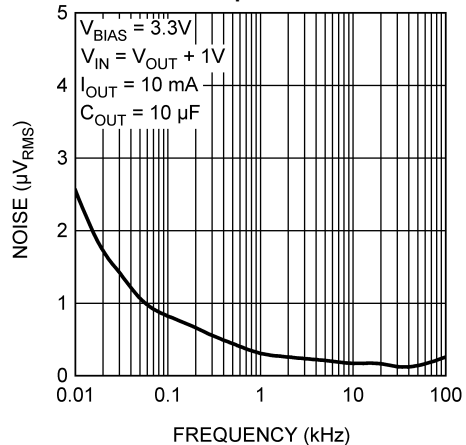
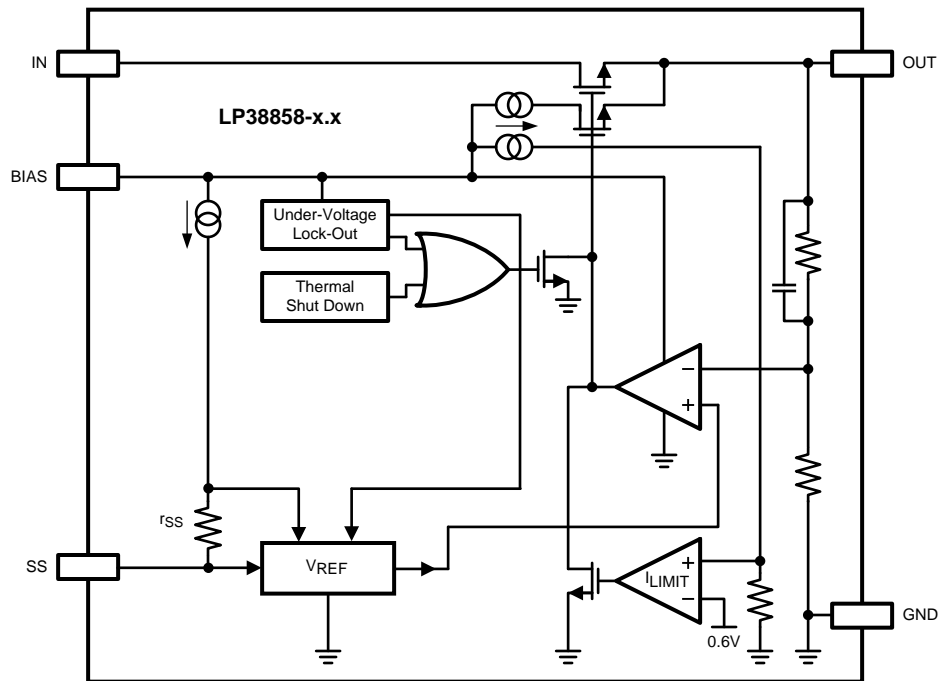

Figure 26.

Block Diagram



APPLICATION INFORMATION

EXTERNAL CAPACITORS

To assure regulator stability, input and output capacitors are required as shown in the [Typical Application Circuit](#).

Output Capacitor

A minimum output capacitance of 10 μF , ceramic, is required for stability. The amount of output capacitance can be increased without limit. The output capacitor must be located less than 1 cm from the output pin of the IC and returned to the device ground pin with a clean analog ground.

Only high quality ceramic types such as X5R or X7R should be used, as the Z5U and Y5F types do not provide sufficient capacitance over temperature.

Tantalum capacitors will also provide stable operation across the entire operating temperature range. However, the effects of ESR may provide variations in the output voltage during fast load transients. Using the minimum recommended 10 μF ceramic capacitor at the output will allow unlimited capacitance, Tantalum and/or Aluminum, to be added in parallel.

Input Capacitor

The input capacitor must be at least 10 μF , but can be increased without limit. Its purpose is to provide a low source impedance for the regulator input. A ceramic capacitor, X5R or X7R, is recommended.

Tantalum capacitors may also be used at the input pin. There is no specific ESR limitation on the input capacitor (the lower, the better).

Aluminum electrolytic capacitors can be used, but are not recommended as their ESR increases very quickly at cold temperatures. They are not recommended for any application where the ambient temperature falls below 0°C.

Bias Capacitor

The capacitor on the bias pin must be at least 1 μF , and can be any good quality capacitor (ceramic is recommended).

INPUT VOLTAGE

The input voltage (V_{IN}) is the high current external voltage rail that will be regulated down to a lower voltage, which is applied to the load. The input voltage must be at least $V_{OUT} + V_{DO}$, and no higher than whatever values is used for V_{BIAS} .

BIAS VOLTAGE

The bias voltage (V_{BIAS}) is a low current external voltage rail required to bias the control circuitry and provide gate drive for the N-FET pass transistor. The bias voltage must be in the range of 3.0V to 5.5V to ensure proper operation of the device.

UNDER VOLTAGE LOCKOUT

The bias voltage is monitored by a circuit which prevents the device from functioning when the bias voltage is below the Under-Voltage Lock-Out (UVLO) threshold of approximately 2.45V.

As the bias voltage rises above the UVLO threshold the device control circuitry becomes active. There is approximately 150 mV of hysteresis built into the UVLO threshold to provide noise immunity.

When the bias voltage is between the UVLO threshold and the Minimum Operating Rating value of 3.0V the device will be functional, but the operating parameters will not be within the specified limits.

SUPPLY SEQUENCING

There is no requirement for the order that V_{IN} or V_{BIAS} are applied or removed.

One practical limitation is that the Soft-Start circuit starts charging C_{SS} when V_{BIAS} rises above the UVLO threshold. If the application of V_{IN} is delayed beyond this point the benefits of Soft-Start will be compromised.

In any case, the output voltage cannot be ensured until both V_{IN} and V_{BIAS} are within the range of specified operating values.

If used in a dual-supply system where the regulator output load is returned to a negative supply, the output pin must be diode clamped to ground. A Schottky diode is recommended for this diode clamp.

REVERSE VOLTAGE

A reverse voltage condition will exist when the voltage at the output pin is higher than the voltage at the input pin. Typically this will happen when V_{IN} is abruptly taken low and C_{OUT} continues to hold a sufficient charge such that the input to output voltage becomes reversed.

The NMOS pass element, by design, contains no body diode. This means that, as long as the gate of the pass element is not driven, there will not be any reverse current flow through the pass element during a reverse voltage event. The gate of the pass element is not driven when V_{BIAS} is below the UVLO threshold.

When V_{BIAS} is above the UVLO threshold the control circuitry is active and will attempt to regulate the output voltage. Since the input voltage is less than the output voltage the control circuit will drive the gate of the pass element to the full V_{BIAS} potential when the output voltage begins to fall. In this condition, reverse current will flow from the output pin to the input pin, limited only by the $R_{DS(ON)}$ of the pass element and the output to input voltage differential. Discharging an output capacitor up to 1000 μ F in this manner will not damage the device as the current will decay rapidly. However, continuous reverse current should be avoided.

SOFT-START

The LP38858 incorporates a Soft-Start function that reduces the start-up current surge into the output capacitor (C_{OUT}) by allowing V_{OUT} to rise slowly to the final value. This is accomplished by controlling V_{REF} at the SS pin. The soft-start timing capacitor (C_{SS}) is internally held to ground until V_{BIAS} rises above the Under-Voltage Lock-Out threshold (ULVO).

V_{REF} will rise at an RC rate defined by the internal resistance of the SS pin (r_{SS}), and the external capacitor connected to the SS pin. This allows the output voltage to rise in a controlled manner until steady-state regulation is achieved. Typically, five time constants are recommended to assure that the output voltage is sufficiently close to the final steady-state value. During the soft-start time the output current can rise to the built-in current limit.

$$\text{Soft-Start Time} = C_{SS} \times r_{SS} \times 5 \tag{1}$$

Since the V_{OUT} rise will be exponential, not linear, the in-rush current will peak during the first time constant (τ), and V_{OUT} will require four additional time constants (4τ) to reach the final value (5τ).

After achieving normal operation, should V_{BIAS} fall below the ULVO threshold the device output will be disabled and the Soft-Start capacitor (C_{SS}) discharge circuit will become active. The C_{SS} discharge circuit will remain active until V_{BIAS} falls to 500 mV (typical). When V_{BIAS} falls below 500 mV (typical), the C_{SS} discharge circuit will cease to function due to a lack of sufficient biasing to the control circuitry.

Since V_{REF} appears on the SS pin, any leakage through C_{SS} will cause V_{REF} to fall, and thus affect V_{OUT} . A leakage of 50 nA (about 10 M Ω) through C_{SS} will cause V_{OUT} to be approximately 0.1% lower than nominal, while a leakage of 500 nA (about 1 M Ω) will cause V_{OUT} to be approximately 1% lower than nominal. Typical ceramic capacitors will have a factor of 10X difference in leakage between 25°C and 85°C, so the maximum ambient temperature must be included in the capacitor selection process.

Typical C_{SS} values will be in the range of 1 nF to 100 nF, providing typical Soft-Start times in the range of 70 μ s to 7 ms (5τ). Values less than 1 nF can be used, but the Soft-Start effect will be minimal. Values larger than 100 nF will provide soft-start, but may not be fully discharged if V_{BIAS} falls from the UVLO threshold to less than 500 mV in less than 100 μ s.

Figure 27 shows the relationship between the C_{OUT} value and a typical C_{SS} value.

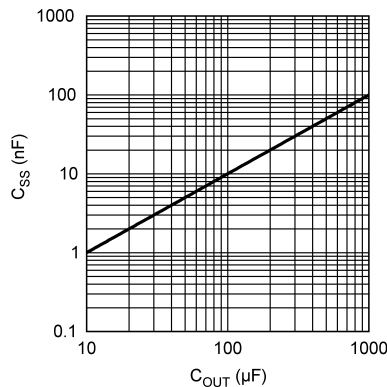

Figure 27. Typical C_{SS} vs C_{OUT} Values

The C_{SS} capacitor must be connected to a clean ground path back to the device ground pin. No components, other than C_{SS} , should be connected to the SS pin, as there could be adverse effects to V_{OUT} .

If the Soft-Start function is not needed the SS pin should be left open, although some minimal capacitance value is always recommended.

POWER DISSIPATION AND HEAT-SINKING

Additional copper area for heat-sinking may be required depending on the maximum device dissipation (P_D) and the maximum anticipated ambient temperature (T_A) for the device. Under all possible conditions, the junction temperature must be within the range specified under operating conditions.

The total power dissipation of the device is the sum of three different points of dissipation in the device.

The first part is the power that is dissipated in the NMOS pass element, and can be determined with the formula:

$$P_{D(PASS)} = (V_{IN} - V_{OUT}) \times I_{OUT} \tag{2}$$

The second part is the power that is dissipated in the bias and control circuitry, and can be determined with the formula:

$$P_{D(BIAS)} = V_{BIAS} \times I_{GND(BIAS)}$$

where

- $I_{GND(BIAS)}$ is the portion of the operating ground current of the device that is related to V_{BIAS} (3)

The third part is the power that is dissipated in portions of the output stage circuitry, and can be determined with the formula:

$$P_{D(IN)} = V_{IN} \times I_{GND(IN)}$$

where

- $I_{GND(IN)}$ is the portion of the operating ground current of the device that is related to V_{IN} (4)

The total power dissipation is then:

$$P_D = P_{D(PASS)} + P_{D(BIAS)} + P_{D(IN)} \quad (5)$$

The maximum allowable junction temperature rise (ΔT_J) depends on the maximum anticipated ambient temperature (T_A) for the application, and the maximum allowable operating junction temperature ($T_{J(MAX)}$).

$$\Delta T_J = T_{J(MAX)} - T_{A(MAX)} \quad (6)$$

The maximum allowable value for junction to ambient Thermal Resistance, θ_{JA} , can be calculated using the formula:

$$\theta_{JA} \leq \frac{\Delta T_J}{P_D} \quad (7)$$

Heat-Sinking the TO-220 Package

The TO-220-5 package has a θ_{JA} rating of 60°C/W and a θ_{JC} rating of 3°C/W. These ratings are for the package only, no additional heat-sinking, and with no airflow. If the needed θ_{JA} , as calculated above, is greater than or equal to 60°C/W then no additional heat-sinking is required since the package can safely dissipate the heat and not exceed the operating $T_{J(MAX)}$. If the needed θ_{JA} is less than 60°C/W then additional heat-sinking is needed.

The thermal resistance of a TO-220 package can be reduced by attaching it to a heat sink or a copper plane on a PC board. If a copper plane is to be used, the values of θ_{JA} will be same as shown in next section for DDPAK/TO-263 package.

The heat-sink to be used in the application should have a heat-sink to ambient thermal resistance, θ_{HA} :

$$\theta_{HA} \leq \theta_{JA} - (\theta_{CH} + \theta_{JC})$$

where

- θ_{JA} is the required total thermal resistance from the junction to the ambient air
- θ_{CH} is the thermal resistance from the case to the surface of the heat-sink
- θ_{JC} is the thermal resistance from the junction to the surface of the case (8)

For this equation, θ_{JC} is about 3°C/W for a TO-220 package. The value for θ_{CH} depends on method of attachment, insulator, etc. θ_{CH} varies between 1.5°C/W to 2.5°C/W. Consult the heat-sink manufacturer datasheet for details and recommendations.

Heat-Sinking the DDPAK/TO-263 Package

The DDPAK/TO-263 package has a θ_{JA} rating of 60°C/W, and a θ_{JC} rating of 3°C/W. These ratings are for the package only, no additional heat-sinking, and with no airflow.

The DDPAK/TO-263 package uses the copper plane on the PCB as a heat-sink. The tab of this package is soldered to the copper plane for heat sinking. shows a curve for the θ_{JA} of DDPAK/TO-263 package for different copper area sizes, using a typical PCB with 1 ounce copper and no solder mask over the copper area for heat-sinking.

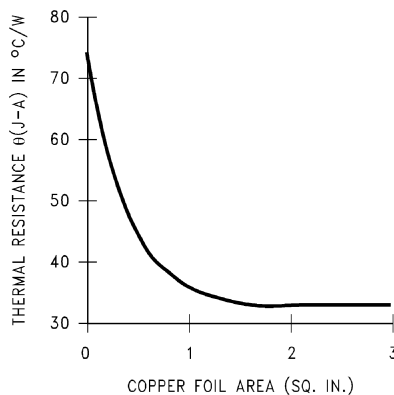

Figure 28. θ_{JA} vs Copper (1 Ounce) Area for the DDPAK/TO-263 package

Figure 28 shows that increasing the copper area beyond 1 square inch produces very little improvement. The minimum value for θ_{JA} for the DDPAK/TO-263 package mounted to a PCB is 32°C/W.

Figure 29 shows the maximum allowable power dissipation for DDPAK/TO-263 packages for different ambient temperatures, assuming θ_{JA} is 35°C/W and the maximum junction temperature is 125°C.

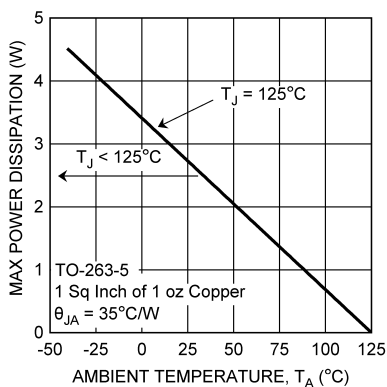

Figure 29. Maximum Power Dissipation vs Ambient Temperature for the DDPAK/TO-263 Package

REVISION HISTORY

Changes from Revision C (April 2013) to Revision D	Page
• Changed layout of National Data Sheet to TI format	13

PACKAGING INFORMATION

Orderable Device	Status (1)	Package Type	Package Drawing	Pins	Package Qty	Eco Plan (2)	Lead/Ball Finish (6)	MSL Peak Temp (3)	Op Temp (°C)	Device Marking (4/5)	Samples
LP38858S-1.2/NOPB	ACTIVE	DDPAK/ TO-263	KTT	5	45	Pb-Free (RoHS Exempt)	CU SN	Level-3-245C-168 HR	-40 to 125	LP38858S -1.2	Samples
LP38858SX-1.2/NOPB	ACTIVE	DDPAK/ TO-263	KTT	5	500	Pb-Free (RoHS Exempt)	CU SN	Level-3-245C-168 HR	-40 to 125	LP38858S -1.2	Samples
LP38858T-1.2/NOPB	ACTIVE	TO-220	NDH	5	45	Green (RoHS & no Sb/Br)	CU SN	Level-1-NA-UNLIM	-40 to 125	LP38858T -1.2	Samples

(1) The marketing status values are defined as follows:

ACTIVE: Product device recommended for new designs.

LIFEBUY: TI has announced that the device will be discontinued, and a lifetime-buy period is in effect.

NRND: Not recommended for new designs. Device is in production to support existing customers, but TI does not recommend using this part in a new design.

PREVIEW: Device has been announced but is not in production. Samples may or may not be available.

OBsolete: TI has discontinued the production of the device.

(2) Eco Plan - The planned eco-friendly classification: Pb-Free (RoHS), Pb-Free (RoHS Exempt), or Green (RoHS & no Sb/Br) - please check <http://www.ti.com/productcontent> for the latest availability information and additional product content details.

TBD: The Pb-Free/Green conversion plan has not been defined.

Pb-Free (RoHS): TI's terms "Lead-Free" or "Pb-Free" mean semiconductor products that are compatible with the current RoHS requirements for all 6 substances, including the requirement that lead not exceed 0.1% by weight in homogeneous materials. Where designed to be soldered at high temperatures, TI Pb-Free products are suitable for use in specified lead-free processes.

Pb-Free (RoHS Exempt): This component has a RoHS exemption for either 1) lead-based flip-chip solder bumps used between the die and package, or 2) lead-based die adhesive used between the die and leadframe. The component is otherwise considered Pb-Free (RoHS compatible) as defined above.

Green (RoHS & no Sb/Br): TI defines "Green" to mean Pb-Free (RoHS compatible), and free of Bromine (Br) and Antimony (Sb) based flame retardants (Br or Sb do not exceed 0.1% by weight in homogeneous material)

(3) MSL, Peak Temp. - The Moisture Sensitivity Level rating according to the JEDEC industry standard classifications, and peak solder temperature.

(4) There may be additional marking, which relates to the logo, the lot trace code information, or the environmental category on the device.

(5) Multiple Device Markings will be inside parentheses. Only one Device Marking contained in parentheses and separated by a "~" will appear on a device. If a line is indented then it is a continuation of the previous line and the two combined represent the entire Device Marking for that device.

(6) Lead/Ball Finish - Orderable Devices may have multiple material finish options. Finish options are separated by a vertical ruled line. Lead/Ball Finish values may wrap to two lines if the finish value exceeds the maximum column width.

Important Information and Disclaimer: The information provided on this page represents TI's knowledge and belief as of the date that it is provided. TI bases its knowledge and belief on information provided by third parties, and makes no representation or warranty as to the accuracy of such information. Efforts are underway to better integrate information from third parties. TI has taken and

continues to take reasonable steps to provide representative and accurate information but may not have conducted destructive testing or chemical analysis on incoming materials and chemicals. TI and TI suppliers consider certain information to be proprietary, and thus CAS numbers and other limited information may not be available for release.

In no event shall TI's liability arising out of such information exceed the total purchase price of the TI part(s) at issue in this document sold by TI to Customer on an annual basis.

TAPE AND REEL INFORMATION



QUADRANT ASSIGNMENTS FOR PIN 1 ORIENTATION IN TAPE



*All dimensions are nominal

Device	Package Type	Package Drawing	Pins	SPQ	Reel Diameter (mm)	Reel Width W1 (mm)	A0 (mm)	B0 (mm)	K0 (mm)	P1 (mm)	W (mm)	Pin1 Quadrant
LP38858SX-1.2/NOPB	DDPAK/TO-263	KTT	5	500	330.0	24.4	10.75	14.85	5.0	16.0	24.0	Q2

TAPE AND REEL BOX DIMENSIONS



*All dimensions are nominal

Device	Package Type	Package Drawing	Pins	SPQ	Length (mm)	Width (mm)	Height (mm)
LP38858SX-1.2/NOPB	DDPAK/TO-263	KTT	5	500	367.0	367.0	45.0

NDH0005D

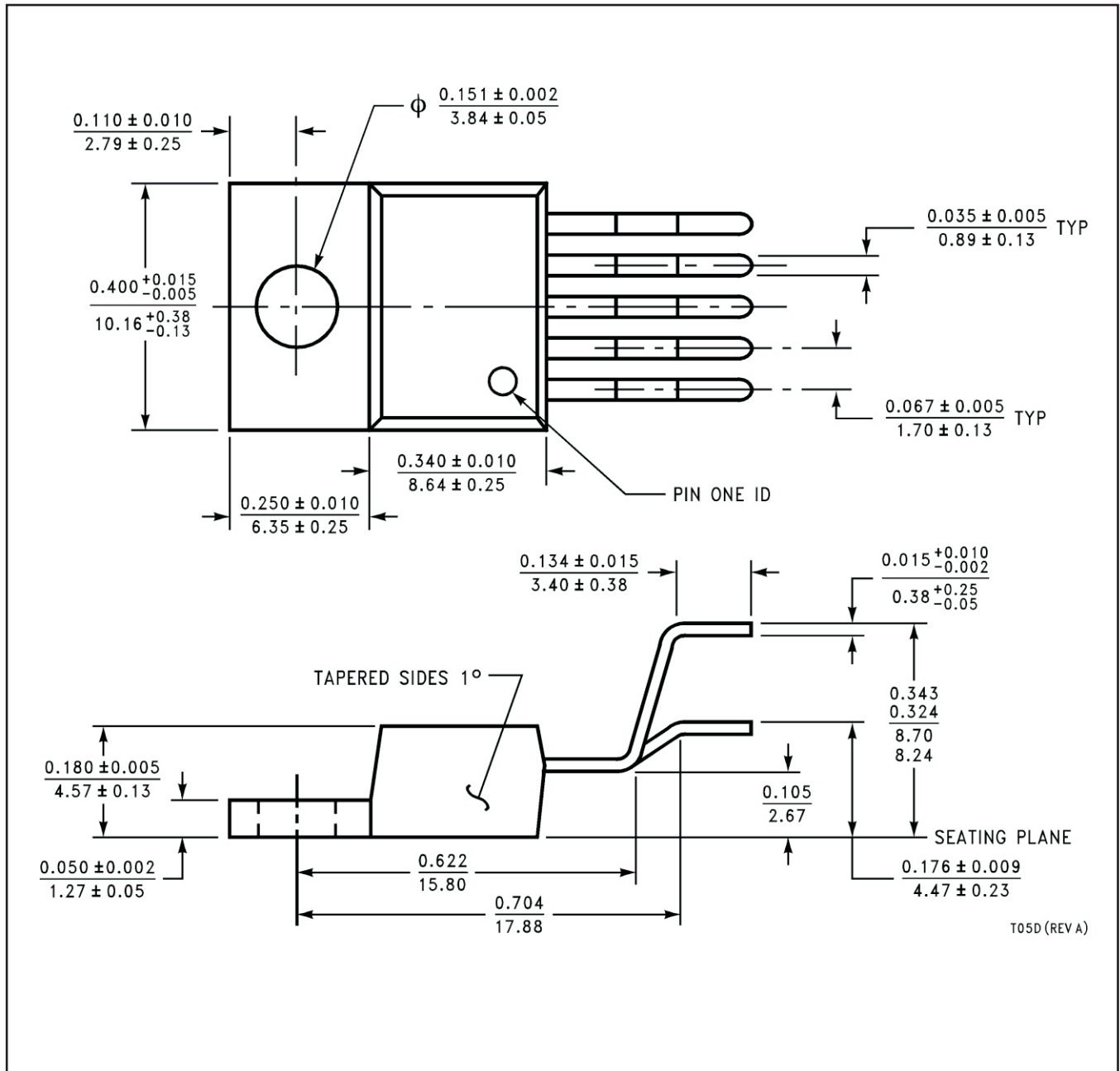

T05D (REV A)

KTT0005B



CONTROLLING DIMENSION IS INCH
 VALUES IN [] ARE MILLIMETERS
 DIMENSIONS IN () FOR REFERENCE ONLY

TS5B (Rev D)

IMPORTANT NOTICE

Texas Instruments Incorporated (TI) reserves the right to make corrections, enhancements, improvements and other changes to its semiconductor products and services per JESD46, latest issue, and to discontinue any product or service per JESD48, latest issue. Buyers should obtain the latest relevant information before placing orders and should verify that such information is current and complete.

TI's published terms of sale for semiconductor products (<http://www.ti.com/sc/docs/stdterms.htm>) apply to the sale of packaged integrated circuit products that TI has qualified and released to market. Additional terms may apply to the use or sale of other types of TI products and services.

Reproduction of significant portions of TI information in TI data sheets is permissible only if reproduction is without alteration and is accompanied by all associated warranties, conditions, limitations, and notices. TI is not responsible or liable for such reproduced documentation. Information of third parties may be subject to additional restrictions. Resale of TI products or services with statements different from or beyond the parameters stated by TI for that product or service voids all express and any implied warranties for the associated TI product or service and is an unfair and deceptive business practice. TI is not responsible or liable for any such statements.

Buyers and others who are developing systems that incorporate TI products (collectively, "Designers") understand and agree that Designers remain responsible for using their independent analysis, evaluation and judgment in designing their applications and that Designers have full and exclusive responsibility to assure the safety of Designers' applications and compliance of their applications (and of all TI products used in or for Designers' applications) with all applicable regulations, laws and other applicable requirements. Designer represents that, with respect to their applications, Designer has all the necessary expertise to create and implement safeguards that (1) anticipate dangerous consequences of failures, (2) monitor failures and their consequences, and (3) lessen the likelihood of failures that might cause harm and take appropriate actions. Designer agrees that prior to using or distributing any applications that include TI products, Designer will thoroughly test such applications and the functionality of such TI products as used in such applications.

TI's provision of technical, application or other design advice, quality characterization, reliability data or other services or information, including, but not limited to, reference designs and materials relating to evaluation modules, (collectively, "TI Resources") are intended to assist designers who are developing applications that incorporate TI products; by downloading, accessing or using TI Resources in any way, Designer (individually or, if Designer is acting on behalf of a company, Designer's company) agrees to use any particular TI Resource solely for this purpose and subject to the terms of this Notice.

TI's provision of TI Resources does not expand or otherwise alter TI's applicable published warranties or warranty disclaimers for TI products, and no additional obligations or liabilities arise from TI providing such TI Resources. TI reserves the right to make corrections, enhancements, improvements and other changes to its TI Resources. TI has not conducted any testing other than that specifically described in the published documentation for a particular TI Resource.

Designer is authorized to use, copy and modify any individual TI Resource only in connection with the development of applications that include the TI product(s) identified in such TI Resource. NO OTHER LICENSE, EXPRESS OR IMPLIED, BY ESTOPPEL OR OTHERWISE TO ANY OTHER TI INTELLECTUAL PROPERTY RIGHT, AND NO LICENSE TO ANY TECHNOLOGY OR INTELLECTUAL PROPERTY RIGHT OF TI OR ANY THIRD PARTY IS GRANTED HEREIN, including but not limited to any patent right, copyright, mask work right, or other intellectual property right relating to any combination, machine, or process in which TI products or services are used. Information regarding or referencing third-party products or services does not constitute a license to use such products or services, or a warranty or endorsement thereof. Use of TI Resources may require a license from a third party under the patents or other intellectual property of the third party, or a license from TI under the patents or other intellectual property of TI.

TI RESOURCES ARE PROVIDED "AS IS" AND WITH ALL FAULTS. TI DISCLAIMS ALL OTHER WARRANTIES OR REPRESENTATIONS, EXPRESS OR IMPLIED, REGARDING RESOURCES OR USE THEREOF, INCLUDING BUT NOT LIMITED TO ACCURACY OR COMPLETENESS, TITLE, ANY EPIDEMIC FAILURE WARRANTY AND ANY IMPLIED WARRANTIES OF MERCHANTABILITY, FITNESS FOR A PARTICULAR PURPOSE, AND NON-INFRINGEMENT OF ANY THIRD PARTY INTELLECTUAL PROPERTY RIGHTS. TI SHALL NOT BE LIABLE FOR AND SHALL NOT DEFEND OR INDEMNIFY DESIGNER AGAINST ANY CLAIM, INCLUDING BUT NOT LIMITED TO ANY INFRINGEMENT CLAIM THAT RELATES TO OR IS BASED ON ANY COMBINATION OF PRODUCTS EVEN IF DESCRIBED IN TI RESOURCES OR OTHERWISE. IN NO EVENT SHALL TI BE LIABLE FOR ANY ACTUAL, DIRECT, SPECIAL, COLLATERAL, INDIRECT, PUNITIVE, INCIDENTAL, CONSEQUENTIAL OR EXEMPLARY DAMAGES IN CONNECTION WITH OR ARISING OUT OF TI RESOURCES OR USE THEREOF, AND REGARDLESS OF WHETHER TI HAS BEEN ADVISED OF THE POSSIBILITY OF SUCH DAMAGES.

Unless TI has explicitly designated an individual product as meeting the requirements of a particular industry standard (e.g., ISO/TS 16949 and ISO 26262), TI is not responsible for any failure to meet such industry standard requirements.

Where TI specifically promotes products as facilitating functional safety or as compliant with industry functional safety standards, such products are intended to help enable customers to design and create their own applications that meet applicable functional safety standards and requirements. Using products in an application does not by itself establish any safety features in the application. Designers must ensure compliance with safety-related requirements and standards applicable to their applications. Designer may not use any TI products in life-critical medical equipment unless authorized officers of the parties have executed a special contract specifically governing such use. Life-critical medical equipment is medical equipment where failure of such equipment would cause serious bodily injury or death (e.g., life support, pacemakers, defibrillators, heart pumps, neurostimulators, and implantables). Such equipment includes, without limitation, all medical devices identified by the U.S. Food and Drug Administration as Class III devices and equivalent classifications outside the U.S.

TI may expressly designate certain products as completing a particular qualification (e.g., Q100, Military Grade, or Enhanced Product). Designers agree that it has the necessary expertise to select the product with the appropriate qualification designation for their applications and that proper product selection is at Designers' own risk. Designers are solely responsible for compliance with all legal and regulatory requirements in connection with such selection.

Designer will fully indemnify TI and its representatives against any damages, costs, losses, and/or liabilities arising out of Designer's non-compliance with the terms and provisions of this Notice.